



BEST 
dormakaba Group

Cylindrical Adaptations by BEST



The easiest lock to install is now the easiest choice to make

TABLE OF CONTENTS

Introduction.....	2	Patented Key System.....	5
9K / 7KC Features.....	2	How to Order.....	6
9K / 7KC Specifications.....	3	Alternate Through-Bolt Options.....	7
9K / 7KC Functions.....	4	Components & Kits.....	7
9K / 7KC Levers & Trims.....	5	KIK Cylinders.....	7

Introduction

Most customers know the 9K is one of the toughest and safest cylindrical locks on the market. In fact, it's been tested to exceed 10 times the BHMA criteria for Grade 1 levers. It comes in bold, innovative designs. Goes in fast and stands up to everyday use and abuse year after year. To that incredible list of benefits, we're adding a new one.

Because in addition to making the 9K compatible with conventional Key-in-Knob or KIK cylinders, we've made it capable of easily adapting to existing large format interchangeable cores. That's right, people can now change out non-BEST locksets with the 9K—or add 9Ks into the mix without rekeying.

In fact, BEST cylindrical locks can be ordered two ways—configured for use with OEM cylinders from another manufacturer (KIK or Schlage, Sargent, Yale and Corbin Russwin LFIC formats), or complete with a keyed KIK cylinder. In either case, we will provide all the necessary components to assure the cylinder and lockset operate together properly and can be installed quickly.

You may prefer to use BEST locks but have doors already prepared for a different through-bolt configuration. To answer, we offer an alternative through-bolt option that enables the 7KC and 9K to retrofit another common door preparation (2 3/4" or 2 5/8" through bolt spacing). Factoring everything in, the BEST 9K could be the one lockset to rule them all.



Features / Benefits

9K – Heavy-duty

- Once installed, no complex disassembly is required to remove the lever. Lever cannot be removed without a key.
- Accepts OEM Key-in-Knob or KIK cylinders from the following manufacturers: Corbin Russwin, Medeco, Sargent, Schlage and Yale. Special tailpiece required (supplied by BEST).
- Accepts OEM Removable Core cylinders from Corbin Russwin, Sargent, Schlage and Yale. Special tailpiece required (supplied by BEST).
- Available in all 9K finishes. (When ordered with KIK cylinder from BEST, 626 finish cylinder provided for 626 and 625 finishes; 606 finish cylinder provided for all other finishes.)
- Available in all keyed functions except H, HJ and C.
- Available in standard BEST door preparation and alternative through-bolt door preparation (2 3/4" and 2 5/8" through-bolt hole spacing).
- Meets all BHMA Grade 1 requirements.
- Door thickness – 1 3/8" to 2 1/4"

NOTE: When a heavy-duty cylindrical lockset is required, our heavy-duty 9K series is recommended.

7KC – Medium-duty

- Once installed, no complex disassembly is required to remove the lever.
- Lever cannot be removed without a key.
- Accepts OEM Key-in-Knob or KIK cylinders from the following manufacturers: Corbin-Russwin, Medeco, Sargent, Schlage and Yale (use OEM-supplied tailpiece).
- Available in all 7KC finishes. (When ordered with KIK cylinder from BEST, 626 finish cylinder provided for 626 and 625 finishes; 606 finish cylinder provided for all other finishes.)
- Available in standard BEST door preparation and alternative through-bolt door preparation (2 3/4" through-bolt hole spacing).
- Meets all BHMA Grade 2 requirements.

9K Specifications	
American National Standard	ANSI A156.2, Series 4000 Grade 1 [formerly FF-H-106C Series 161].
Backset	9K3 Series: 2 3/4" 9K4 Series: 3 3/4" 9K5 Series: 5"
Certifications	Listed by Underwriter's Laboratories for use on 3-hour, A-label single swinging doors (4'x10'); GYJT Builders Hardware single-point locks or latches.
Chassis	Critical latch and chassis components are brass or corrosion- treated steel.
Door thickness	Available for 1 3/4" to 2 1/4" doors. Spacers available for 1 3/8" doors
Finishes	605 – bright bras 606 – satin bras 611 – bright bronze 612 – satin bronze 613 – oxidized satin bronze, oil rubber 618 – bright nickel plated 619 – satin nickel plated 622 – bright chromium plated 625 – bright chromium plated
Latch	Solid brass 9/16" throw. Front 2 1/4" x 1 1/8" beveled
Lever handles	Lever handles are a high-quality zinc alloy. Trim components are brass or bronze. Body is approximately 1 5/8" in diameter; handle is approximately 4 3/4" long (from centerline of chassis). #14 and #15 levers conform to California Administrative Code Title 19 and Title 24. All three styles of levers conform to the Illinois Accessibility Standard.
Mounting	In addition to standard door preparation (ANSI A115.2 for 1 3/4" doors), two additional holes are needed for through-bolts. Through-bolts require 5/16" diameter holes located at clock positions 12 and 6. A drill jig is provided to ensure accuracy of the holes. Drill jig not available for ATB mounting option. Projection on door – Approximately 2 3/4" when mounted on 1 3/4" door.
Roses	C – 3" Convex D – 3 1/2" Convex K – 3" Convex, no ring L – 3 1/2" Convex, no ring
Strike	STK – Conforms to ANSI A115.2 (2 3/4" x 1 1/8" with curved lip & box). S3 – Conforms to ANSI A115.2 for 1 3/4" doors (4 7/8" x 1 1/4" with curved lip). S3-7/8 – Conforms to ANSI A115.2 for 1 3/4" doors (4 7/8" x 1 7/8" flat).
Products are covered by one or more of the following patents	
U.S.	D290,085 4,437,695 4,428,212 4,843,852 4,318,558 4,428,570 4,262,507 4,496,178 4,779,908 5,116,170
Canada	1,184,773 1,194,057 1,229,358

Other products patent pending



7KC Specifications	
Backset	7K2 Series: 2 3/8" 7K3 Series: 2 3/4" 7K4 Series: 3 3/4"
Certifications	This product is listed in BHMA Directory of Certified Locks and Latches as conforming to ANSI A156.3, Grade 2. California Administrative Code Title 19 and 24. Illinois Accessibility Standard. American National Standard – Listed by Underwriters Laboratories for use on 3-hour, A-label single swinging doors (4' x 8').
Door thickness	1 3/8" to 2"
Finishes	605 – bright bras 606 – satin bras 612 – satin bronze 613 – oxidized satin bronze, oil rubber 625 – bright chromium plated 626 – satin chromium plated
Latch	1/2" throw deadlocking latch. Front: 2 1/4" x 1 1/8" x 5/32" standard for 2 3/4" backset; 2 1/4" x 1" x 5/32" for 2 3/8" backset
Mounting	In addition to standard door preparation (ANSI A115.2 for 1 3/4" doors), two additional holes are needed for through-bolts. Through-bolts require 5/16" diameter holes located at clock positions 12 and 6. A drill jig is provided to ensure accuracy of the holes. Drill jig not available for ATB mounting option.
Roses	D – 3 1/2" Convex diameter mounting screws concealed
Strike	STK – (standard) – 2 3/4" x 1 1/8" with curved lip and box (ANSI A115.2 for 1 3/8" doors). S3 – 4 7/8" x 1 1/4" with curved lip and box (ANSI A115.2 for 1 3/4" doors).

Products are covered by one or more of the following patents

U.S. 4,843,852 D,290,085 4,930,822

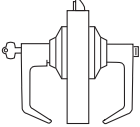
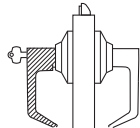
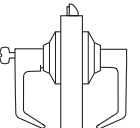
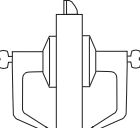
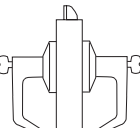
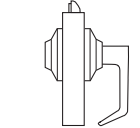
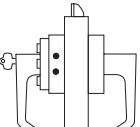

9K & 7KC Functions

Function & Diag. [ANSI No.]	Description	Outside Lever		Inside Lever	
		Latched by	Locked by	Unlocked by	Locked by
9K & 7KC Functions					
Entry (AB) F109 	Rotating inside lever Rotating the outside lever – only when the inside push button is out Turning key in outside lever	Pushing the inside button Pushing and turning the inside button. Turning the button keeps the outside lever locked until the button is turned back	Turning the key in the outside lever (only when the button is not turned) Rotating the inside lever (only when the button is not turned) Closing the door (only when the button is not turned)	Cannot be locked	Always Unlocked
Storeroom (D) F86 	Turning key in the outside lever Rotating inside lever	Always locked	Cannot be unlocked	Cannot be locked	Always Unlocked
Classroom (R) F84 	Rotating inside lever Turning key in outside lever when outside lever is locked Rotating outside lever when not locked by key	Turning key in outside lever	Turning key in outside lever	Cannot be locked	Always Unlocked
9K-only Functions					
Intruder (IND) 	Rotating inside lever Rotating outside lever only when not locked by inside or outside key	Turning key in the inside lever Turning the key in the outside lever	Turning key in the inside lever Turning the key in the outside lever	Cannot be locked	Always Unlocked
Electrically locked (DEL) 	Rotating the inside lever Rotating the outside lever only when power is off Turning the key in the outside lever	Applying 24 volts DC Outside lever remains locked only while power is on	Switching off 24 volts DC	Cannot be locked	Always Unlocked
Electrically unlocked (DEU) 	Rotating the inside lever Turning the key in the outside lever Rotating the outside lever when not locked by key	No outside lever – Blank rose	No outside lever – blank rose	Cannot be locked	Always Unlocked
		Mechanical		Electronic	
Cylindrical latch key override (DV) 	Dead locking latchbolt operated by lever either side, except when outside lever is locked by internal motor drive mechanism; latchbolt is deadlocked		Internal motor drive mechanism operated by time-activated electronic signal or presenting valid card / PIN. Green light indicates valid access. Red light and sounder indicate invalid access attempt. Lock records card number, time, date and type of event.		

Note: Other functions available, refer to 9K Series catalog.

9K Heavy-Duty Levers & Trims



7KC Medium-Duty Levers & Trims



CORMAX™ Patented Keying System

BEST® CORMAX™ is the premier patented keying system offered by BEST. CORMAX will meet your needs for security, key control, and convenience. A simple solution with no compromising allowed. CORMAX is the upgrade path for existing BEST Standard, Premium, and MX8 customers; and it is an essential element of non-residential access control as security administrators strive to eliminate the unauthorized duplication of keys.

CORMAX offers the following features and benefits:

- A long-term US utility patent that guarantees the extended useful life of the system through 2027.
- A second, independent locking mechanism that utilizes a patented set of built-in side pins to provide higher security.
- Several levels of geographical exclusivity, including national exclusivity, are available via the patented side pin feature.
- CORMAX cores and keys are available exclusively through BEST sales offices. Key blanks are only sold to individuals authorized by the customer to ensure key blanks do not end up in the possession of unauthorized personnel either inside or outside the customer's facility.
- CORMAX cores™ are certified to meet the security, safety, and reliability requirements of BHMA A156.5 Grade 1.
- Picking and drilling resistance options are available if higher levels of security are desired.
- Complete factory masterkeying service offered, and at no charge with purchase of BEST locksets and PHI exit devices.
- Keyways are organized in families of four keyways each, with double-milled and quad-milled key levels to facilitate the design of masterkey systems in multi-building campuses.
- BEST CORMAX cores are compatible with all existing BEST interchangeable core housings, eliminating the need for new or modified locksets.



How to Order

9K Heavy-Duty Levers How To Order

9K3	6	AB	15	D	STK	626	KD
Backset	Core Housing	Function Code	Lever	Trim Style	Strike Package	Standard Finishes	Options
9K3 – 2 3/4" 9K4 – 3 3/4" 9K4 – 5"	0 – keyless functions or competitive cylinder (IC and non-IC) 6 – 6 pin non-IC cylinder	AB – entrance D – storeroom R – classroom etc.	♿ 14 – curved return ♿ 15 – contour angle return ♿ 16 – curved no return	C – 3" D – 3 1/2"	STK – standard S3 – ANSI	605 606 612 613 625 626 690	OB* – non-IC zero-bitted KA* – non-IC keyed alike KD* – non-IC keyed different COR** – non-IC Corbin Russwin MED** – non-IC Medeco SAR** – non-IC Sargent SCH** – non-IC Schlage YAL** – non-IC Yale CORRC** – Corbin Russwin removable core SARRC** – Sargent removable core SCHRC** – Schlage removable core (14 and 15 lever only) YALRC** – Yale removable core ATB*** – 2 3/4" through-bolt ATB2*** – 2 5/8" through-bolt

* Six-pin cylinder in Schlage "C" included with OB, KA and KD options. Must specify "6" for core housing.

** Cylinder not included with OEM options. "0" must be specified for core housing.

*** Only available on D rose; not available for 9K stand-alone electronic products or IDH Max.

How to Order: 7KC Medium-Duty Levers

7KC3	6	AB	15	D	STK	626	KD
Backset	Core Housing	Function Code	Lever	Trim Style	Strike Package	Standard Finishes	Options
7KC2 – 2 3/8" 7KC3 – 2 3/4" 7KC4 – 3 3/4" 7KC5 – 5"	0 – keyless 6 – 6 pin non-IC cylinder	AB – entrance D – storeroom R – classroom etc.	♿ 14 – curved return ♿ 15 – contour angle return ♿ 16 – curved no return	D – 3 1/2"	STK – standard S3 – ANSI	605 606 612 613 625 626	OB* – non-IC zero-bitted KA* – non-IC keyed alike KD* – non-IC keyed different OEM** – non-IC OEM ATB*** – alternate through-bolt

* Six-pin cylinder in Schlage "C" included with OB, KA and KD options. Must specify "6" for core housing.

** Cylinder not included with OEM option. "0" must be specified for core housing.

Alternate Through-Bolt or ATB Options

The alternate through-bolt option for the 9K and 7KC Cylindrical Lock is designed to ease the installation when retrofitting a competitor product. Many commercial grade cylindrical locksets utilize a through-bolt hole spacing of 2 3/4", whereas standard BEST cylindrical locks utilize a 2 35/64" spacing. On the 9K and 7KC, ATB option is only available for locks that use the D rose.

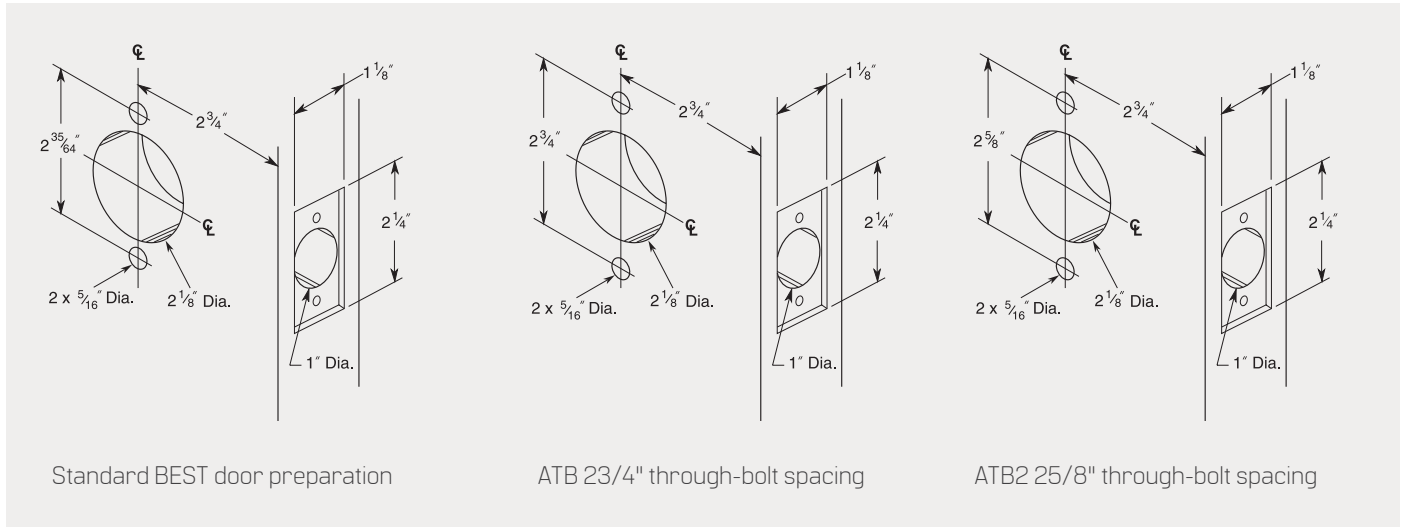

Components & Kits

Key-in-Knob Cylinders

BEST cylindrical locks can be ordered complete with a keyed KIK cylinder provided by BEST. All the necessary components to assure the cylinder and lockset operate together properly will be provided.

KD – Bag set includes a combined cylinder, two cut keys and a selection of tailpieces. Cylinders have a unique combination, which is noted on the keys. Available in either brass (606) or chrome (626).

KA – Bag set includes a combined cylinder, two cut keys and a selection of tailpieces. Cylinders are sold in sets of four, all having the same combination. Combination is noted on the keys. Available in either brass (606) or chrome (626). When ordered with a lock, locks will be packaged four to a box to prevent mixing of cylinder codes

OB – Bag set includes a combined cylinder, two uncut keys and a selection of tailpieces. All barrels combined to a zero cut. Keys are uncut and blank. Available in either brass (606) or chrome (626). This option is intended for pinning by the distributor or customer, so the uncut keys can be cut to the proper codes after combining.

Keyed cylinders may also be purchased from BEST independently from a lockset by specifying the part numbers as shown.

Backset	Core Housing
1888955	Keyed Different non-IC cylinder – 626
1888913	Keyed Different non-IC cylinder – 606
1891329	Keyed Alike non-IC cylinder – 626 (set of 4)
1891287	Keyed Alike non-IC cylinder – 606 (set of 4)
1888798	Zero-Bitted non-IC cylinder – 626
1888756	Zero-Bitted non-IC cylinder – 606



Key-in-Knob Cylinder



B55708 Tailpiece

NOTE: When using the cylinders shown (right) with a 9K lock, a B55708 tailpiece is required (not included with cylinder).



CORPORATE HEADQUARTERS

6161 EAST 75TH STREET
INDIANAPOLIS, IN 46250 USA

Phone 855-365-2407

bestaccess.com

For questions about ordering and to be sure you get the right configuration for your needs, [contact your BEST dormakaba sales representative.](#)
6161 East 75th Street, Indianapolis, IN 46250 USA | [855-365-2407](tel:855-365-2407) | bestaccess.com

BEST is a trademark of dormakaba Holding® 2020 All rights reserved. BEST is a member of the dormakaba Group, one of the top three providers for access and security solutions, globally.

